



# SCHEMATIC DIAGRAM (for Main/Mechanism/LED/Graphic E.Q./Batter/ Power Supp

1 | 2 | 3 | 4 | 5

## B MAIN CIRCUIT

A

B

C

D

E

F

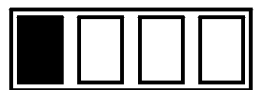
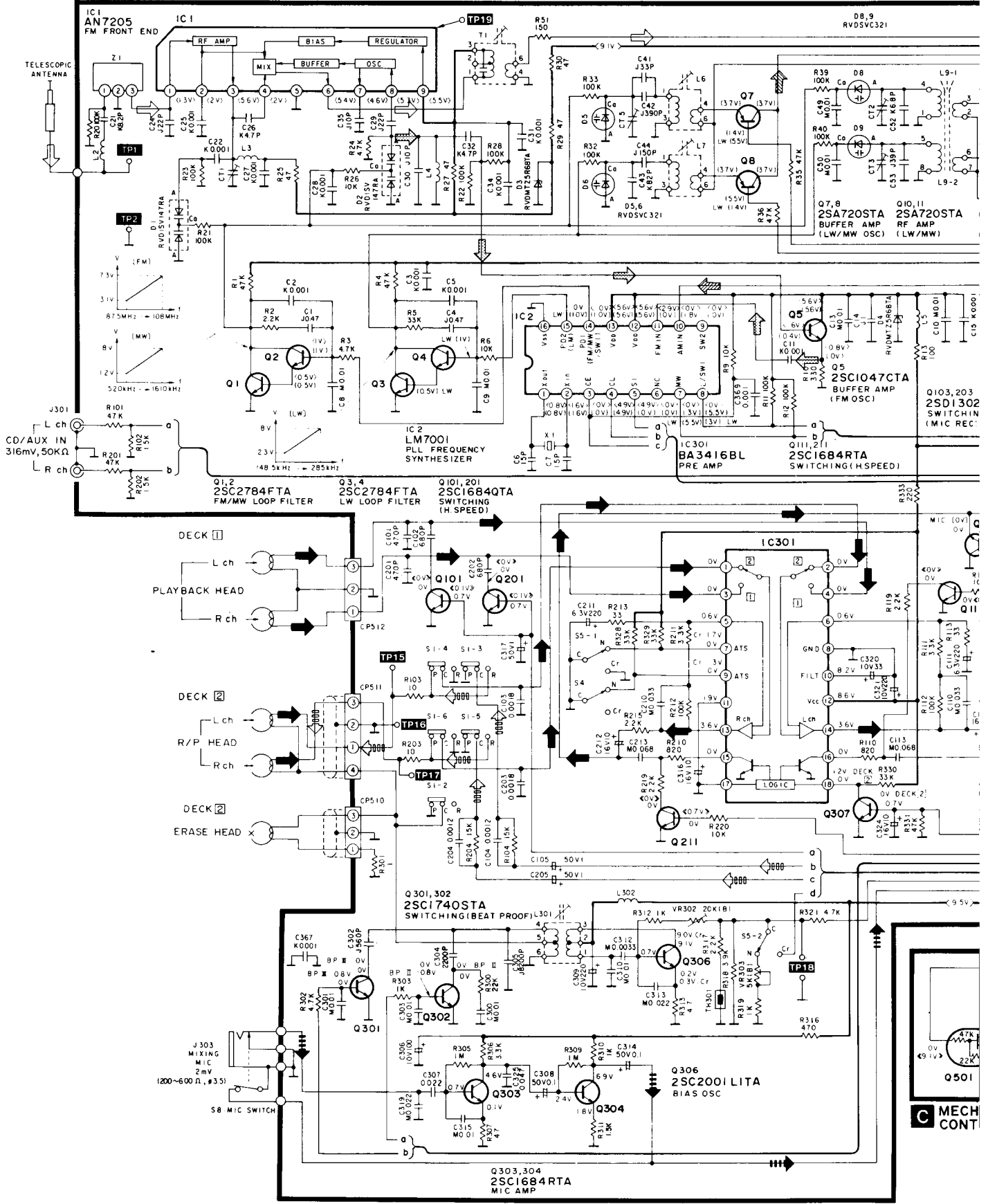

# Supply Circuit (Parts list on page 22~28.)

6

7

8

9

10

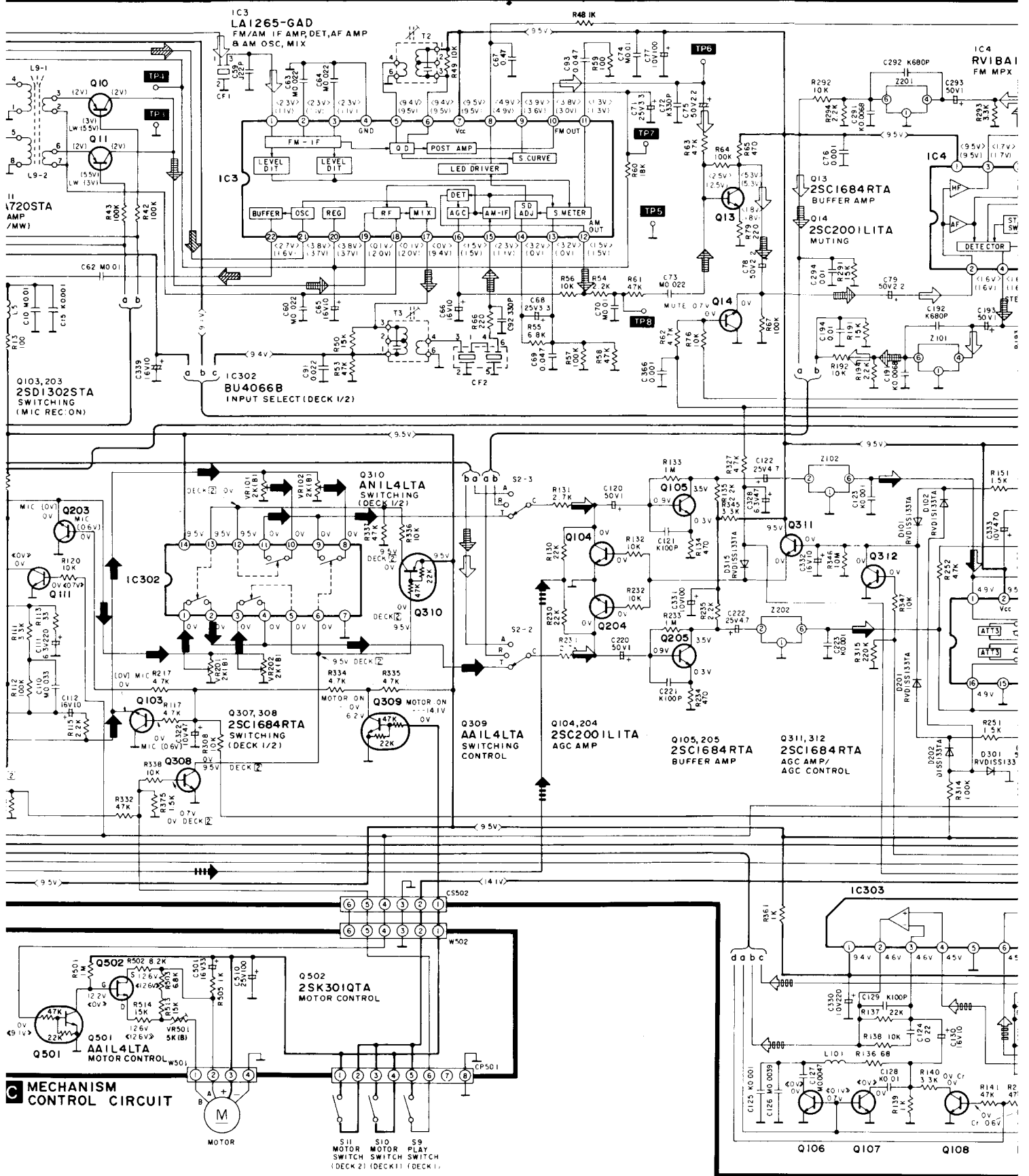

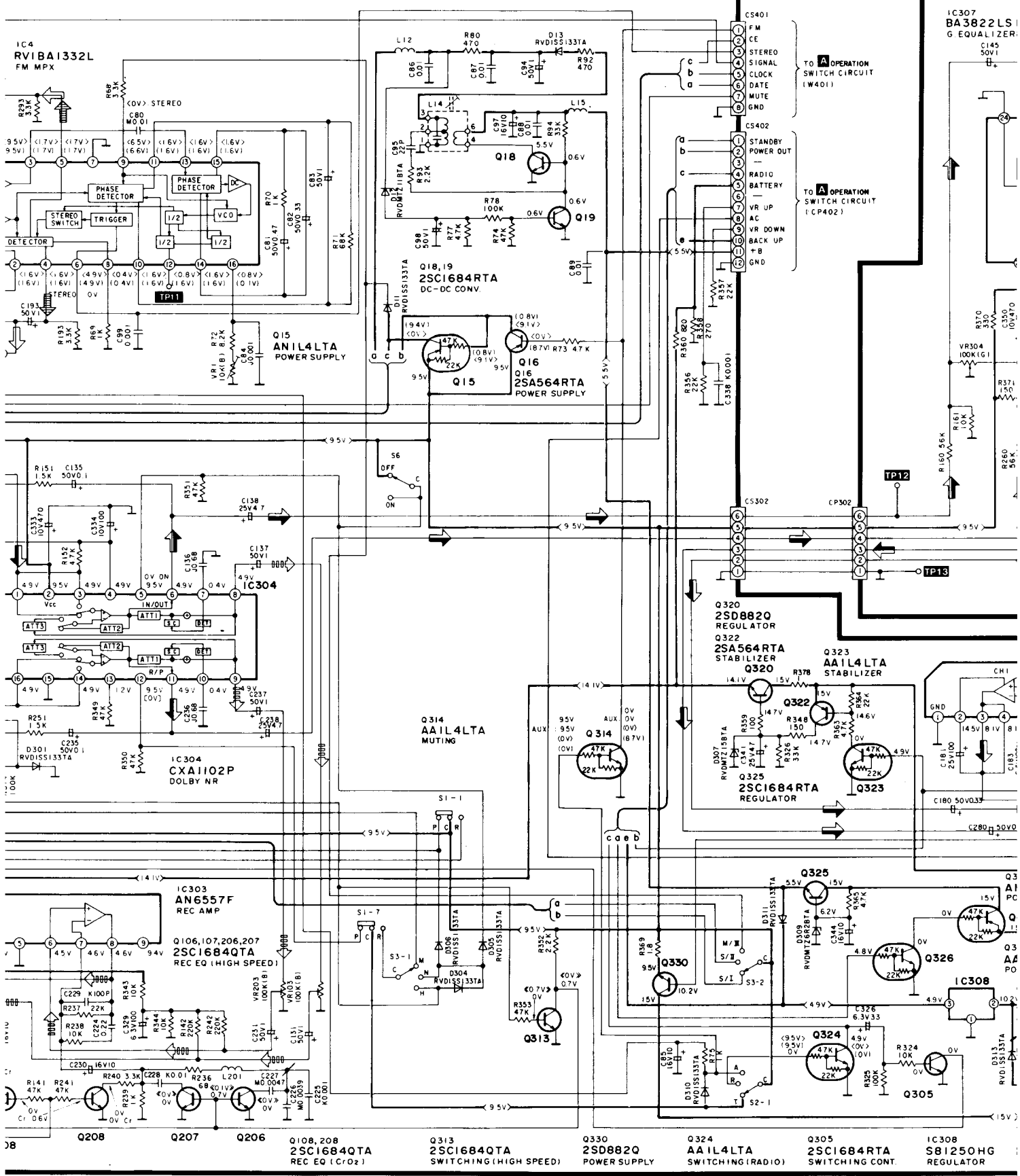

Q108, 208 2SC1684QTA REC EQ (IC02)

Q313 2SC1684QTA SWITCHING (HIGH SPEED)

Q330 2SD882Q POWER SUPPLY

Q324 AA1L4LTA SWITCHING (RADIO)

Q305 2SC1684RTA SWITCHING CONT.

IC308 SB1250HG REGULATOR



### D GRAPHIC EQUALIZER AMP/XBS AMP CIRCUIT

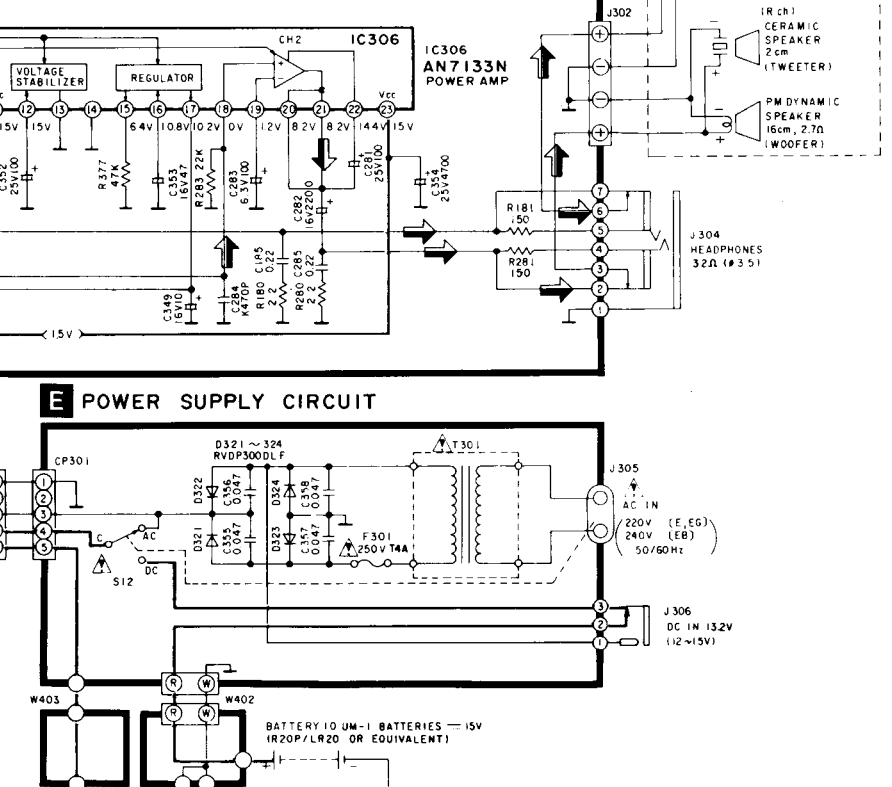
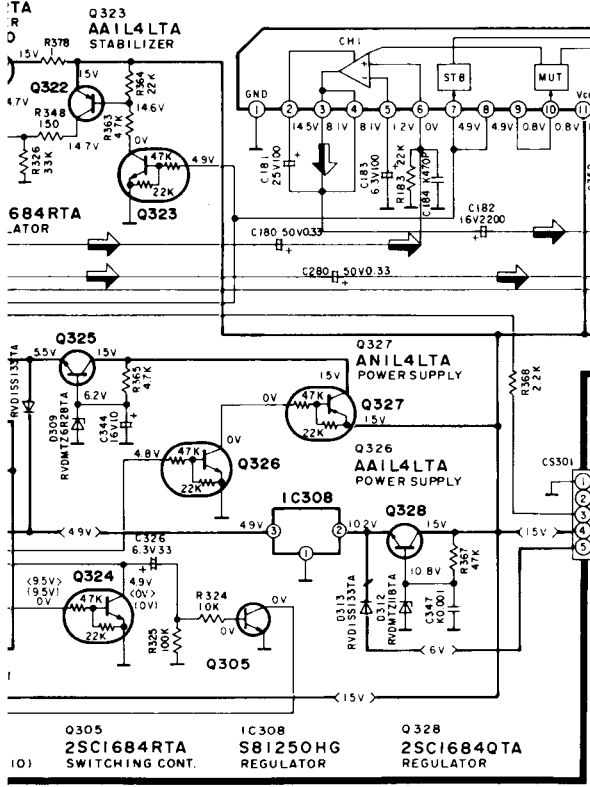
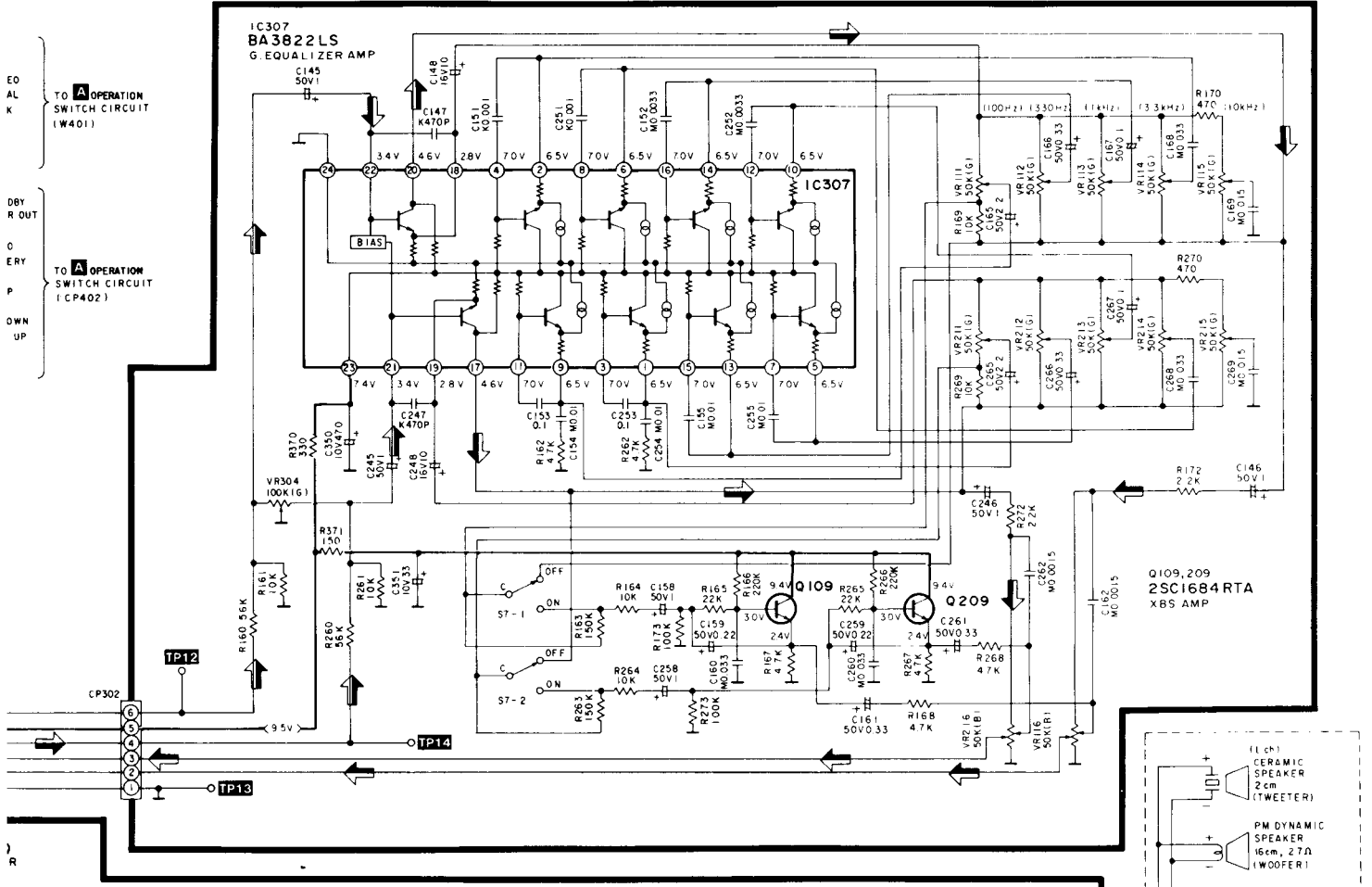

Q305 2SC1684RTA SWITCHING CONT.  
 IC308 S81250HG REGULATOR  
 Q326 AN14LTA POWER SUPPLY  
 Q327 AN14LTA POWER SUPPLY  
 Q328 2SC1684QTA REGULATOR

IC306 AN7133N POWER AMP  
 BATTERY 10 UM-1 BATTERIES — 15V (R20P/LR20 OR EQUIVALENT)  
 BACK-UP FOR MEMORY BATTERY 4 UM-3 BATTERIES — 6V (R6P/LR6 OR EQUIVALENT)

